

DETAIL C
SCALE 4:1

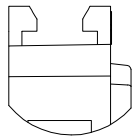

DETAIL A
SCALE 4:1

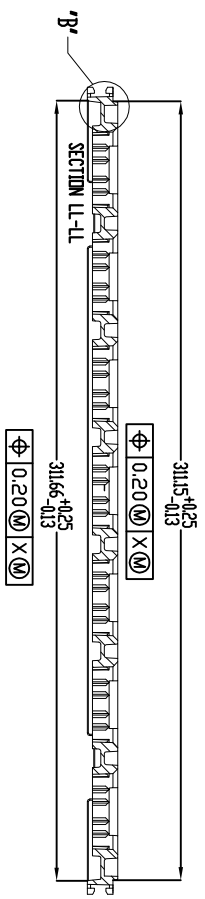
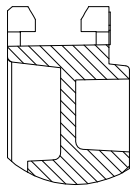

DETAIL B
SCALE 4:1

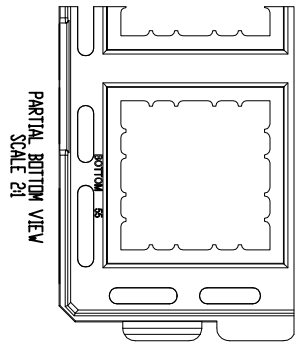

PARTIAL BOTTOM VIEW
SCALE 2:1

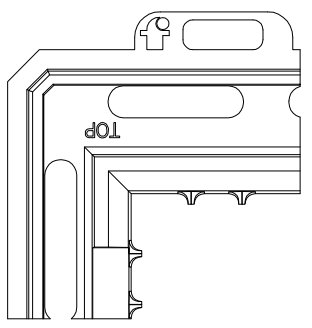
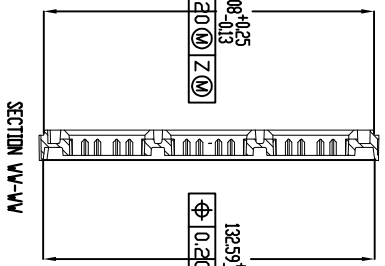
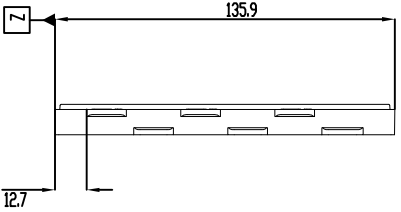

DETAIL S
SCALE 4:1

NOTES : (UNLESS OTHERWISE SPECIFIED)
1. NUMBER OF POCKET : 3 X 7 = 21 POCKETS

TOLERANCES UNLESS OTHERWISE SPECIFIED
DECIMAL :
.X ±.25
.XX ±.13
.XXX ±.13
ANGULAR : ±5°
ANGULAR : ±



6024 Silver Creek Valley Road,
San Jose, CA 95138
PHONE: (408) 284-8200
FAX: (408) 284-3572

TITLE: GUB68 SHIPPING TRAY		SCALE N/A
STOCK NO. N/A	DRAWING NO. MSC-1449-A	REV 00
DO NOT SCALE DRAWING		SHEET 1 OF 2

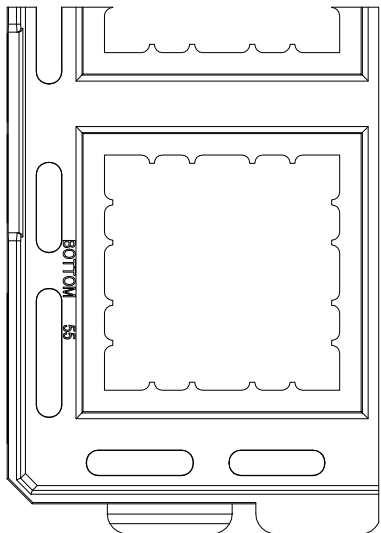
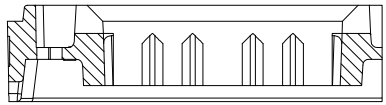
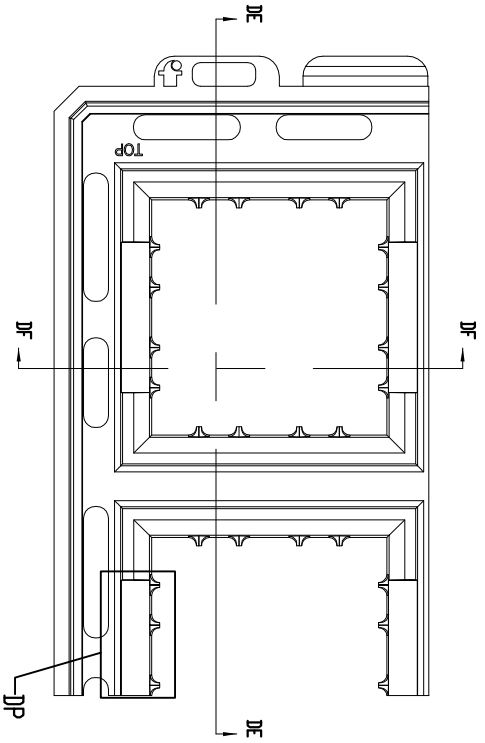

SECTION DE-DE
SCALE 3 : 1

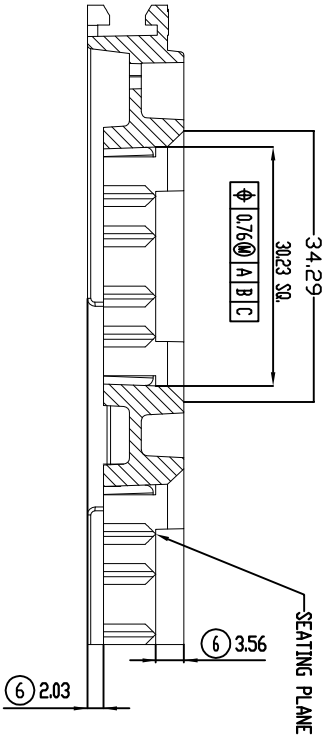

SECTION DE-DE
SCALE 3 : 1

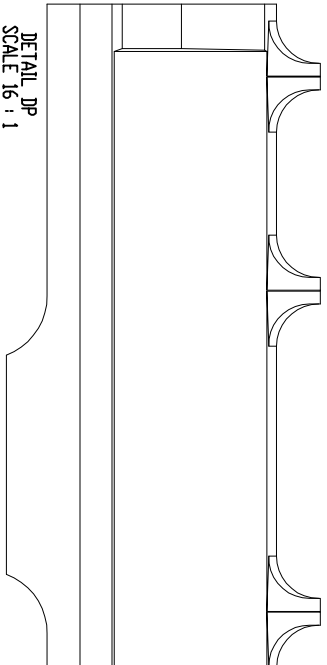

DETAIL DP
SCALE 16 : 1

TOLERANCES UNLESS
OTHERWISE SPECIFIED
DECIMAL : X ±.25
.XX ±.13
.XXX ±.13
ANGLE : 35°
ANGULAR : ±



6024 Silver Creek Valley Road,
San Jose, CA 95138
PHONE: (408) 284-8200
FAX: (408) 284-3572

TITLE:

GU68 SHIPPING TRAY

SCALE
N/A

STOCK NO. N/A

SIZE
N/A

DRAWING NO. MSC-1449-A

REV
00

DO NOT SCALE DRAWING

SHEET 2 OF 2