

### Features & Benefits

- 5.3 V, 1 A output
- WPC 1.1.2 (Qi) compliant for interoperability
- Compact form factor for fast prototyping
- Layout module provided for direct copy to system board
- Optimized PCB reference layout and fully-tested BOM
- Programmable FOD setting via external resistor simplifies tuning process
- Integrated full-bridge synchronous rectifier and LDO for low BOM cost, low manufacturing cost, and small PCB area

### Evaluation Kit Contents

- Fully-assembled P9025AC-R-EVK reference board
- Application notes, datasheets, manuals, guides, videos, layout files, and other digital resources can be found at: [idt.com/P9025AC-R-EVK](http://idt.com/P9025AC-R-EVK)

### Description

The P9025AC-R-EVK is a turnkey 5 Watt, Qi-compliant wireless power receiver reference kit for fast prototyping and design integration. The kit consists of an easy-to-use reference board and comprehensive support collateral that significantly eases design-in effort and minimizes time-to-market.

An associated layout module enables direct instantiation on to a system board, while an optimized and fully-tested Bill-of-Materials (BOM) takes the guess-work out of component selection. Foreign Object Detection (FOD) tuning is supported via selectable pre-programmed curve settings and technical documentation. The P9025AC-based solution is well-suited for a wide range of applications, including PC peripherals, furniture, medical devices, and other portable devices still hindered by traditional contact-based charging bases or cables.

IDT's wireless power receiver solution is complemented by the P9038-R-EVK Qi-compliant 5 Watt wireless power transmitter reference kit. Visit: [idt.com/P9038-R-EVK](http://idt.com/P9038-R-EVK) to learn more.

**Figure 1. Reference Board Illustration**

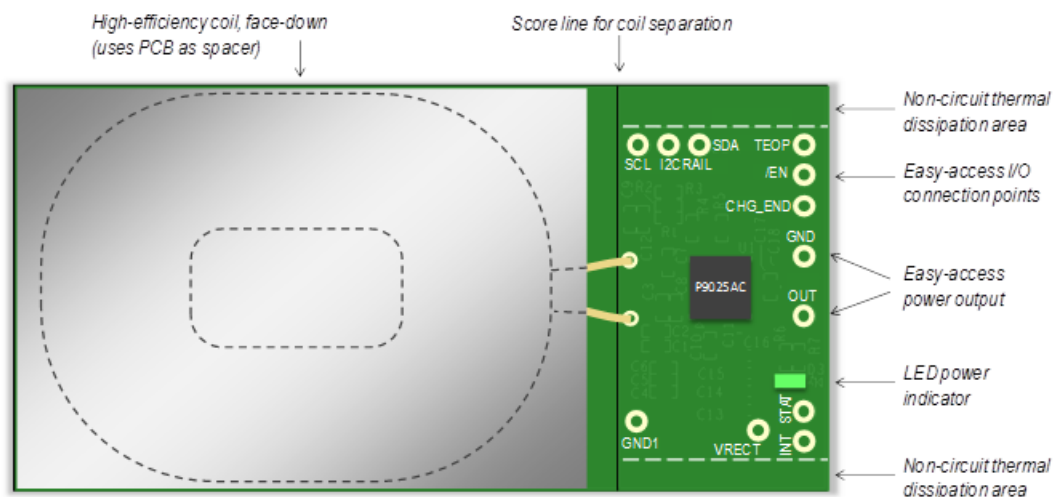

## Usage Guide

This reference board is designed to demonstrate the performance and functionality of the P9025AC as a fully-functional Qi-compliant wireless power receiver unit. In most cases, this board can be wired into an existing system for evaluation and prototyping.

### Quick Start Guide

Follow these simple steps to power-up and begin using the P9025AC-R-EVK board:

1. Place board on wireless power transmitter pad with components facing up  
*Note: coil is facing down so that the PCB acts as a spacer for optimal power transfer*
2. Verify that the green LED is illuminated - power is being transferred
3. Optional: use wires to connect 5.3 V output pads to desired load

### Output Power

The output of the P9025AC's LDO regulator is a plated via labeled OUT, and the DC ground return path is labeled GND. The output provides a nominal 5.3 V with 1 A output current capability. The voltage is intentionally set 0.3 V higher than the standard 5 V rail to provide extra headroom for voltage drops that may be encountered in the system under heavy loads. The plated vias have a 10 mil diameter, allowing for 28-gauge wire or smaller.

### Qi Compliance & Certification

The P9025AC-R-EVK reference board is designed to be compliant to the WPC 1.1.2 Qi specification, but it is not Qi-certified. This distinction is important because a Qi-certified product has completed a strict interoperability testing protocol in its final form factor. That means, the product containing this board or using the reference layout and bill-of-materials should be certified separately.

With that said, the P9025AC provides all of the necessary features and flexibility needed to attain Qi-certification. By using the provided reference design, a system prototype can be created with minimal changes, and thus, minimal engineering risk.

To learn more about attaining Qi-certification, visit:  
<http://www.wirelesspowerconsortium.com/developers/product-testing-and-registration.html>

### LED Power Indicator

The P9025AC-R-EVK is equipped with a single green LED power indicator connected from OUT to STAT. This LED will be illuminated when the system reaches the desired operating point and enables the DC voltage output. This LED is entirely optional and is included for evaluation purposes only. When illuminated, it draws less than 1 mA of current from the output. If desired, the brightness of the LED can be increased by lowering the value of resistor R7.

### Test Point Accessibility

The P9025AC-R-EVK reference board was designed so that the core layout could be easily copied to an existing system board design. For this reason, all of the necessary inputs and outputs are placed toward the edge of the board to eliminate uncertainty in escape routing. For more information about copying the digital layout files, refer to application note [AN-899 P9025AC Layout Guidelines](#)

When prototyping with this board, it is important to use a low-resistance wire that is rated for the expected output current. This will avoid damage to the wire and minimize voltage drops on its way to the load.

### PCB Coil Spacer (Upside-down coil)

A good wireless power transfer system should maintain a small separation gap between the transmitter coil and the receiver coil. The Qi specification requires a separation gap of 1.75 to 2.5 mm on the receiver side. For the reference board, the receiver coil has been mounted upside-down so that the PCB can provide the separation typically achieved by the final product casing. While the coil itself is protected by non-conductive encapsulation, is recommended to use some type of spacer to archive optimal power transfer efficiency.

For prototyping, it may be necessary to flip the coil over so that the winding are facing up. This is done by simply prying it off the board, peeling off the ferrite adhesive, flipping it over, and sticking it back on the board. Care should be taken not to break the ferrite, as it is somewhat brittle. To see a video demonstration, visit: [idt.com/P9025AC-R-EVK](http://idt.com/P9025AC-R-EVK)

## Separating the Coil from the Board

The P9025AC-R-EVK reference board has been precisely tuned for the stock coil attached to the PCB. The PCB material that extends under the coil ferrite is for spacing and physical stability only. The board has been designed with a score line enabling users to snap-off of the PCB section on which the coil ferrite is glued. This can be done by carefully placing the board on the edge of a table and applying downward pressure on the coil.

It is also possible to remove the PCB from the coil, as described in the "PCB Coil Spacer (Upside-down coil)" section. This is easily done by prying the two components apart. While doing this, take care not to damage the coil leads. In some cases, especially when planning to extend the coil leads, it's best to unsolder the coil leads from the PCB prior to snapping or separating the PCB. In addition, any wires used to extend the leads of the coil should be twisted to help cancel the inductance of the new wire.

To see a video demonstration of separating the coil mount or removing the coil from the board, visit: [idt.com/P9025AC-R-EVK](http://idt.com/P9025AC-R-EVK).

## Minimizing the Physical PCB Area

When space is limited, the P9025AC-R-EVK board can be made smaller in two ways. First, the coil can be separated from the board as explained in the section titled "Separating the Coil from the Board". Second, there are two areas on the edge of the component area that can be sawed off. There is no active circuitry in these areas. To see a video demonstration, visit: [idt.com/P9025AC-R-EVK](http://idt.com/P9025AC-R-EVK).

## Thermal Considerations

The small size of the P9025AC-R-EVK limits the board's ability to dissipate heat into the ambient space. With a continuous 5 W load in a room temperature, still-air environment, it is normal to see localized board temperatures near 70 °C. Copying the reference layout to a larger board, or a board with more layers will reduce the temperature. For more detailed information about thermal considerations, refer to [AN-899 P9025AC Layout Guidelines](#).

## Physical Specifications

The following specifications are based on the Gerber files:

- Width: 33.8 mm
- Component area length (from edge to score line): 17.3 mm
- Total board length (from edge to edge): 67.8 mm
- PCB thickness: 1.6 mm

The following specifications were measured by hand on one board sample using Würth Elektronik coil 760308103202. These values are for estimation purposes only. Actual specifications may vary.

- Thickness of active circuit (components and solder, not including coil): ~ 2.7 mm
- Total thickness (including coil and adhesive): ~ 3.1 mm
- Total weight (including plastic spacer and rubber feet): ~ 17 grams

Note that the thickness of the solution can be minimized when the coil has been removed from the coil mount so that the coil ferrite is sitting next to the active circuit area. In that case, the total thickness of the solution is dependent on the thickness of the coil or components.

# Board Schematic

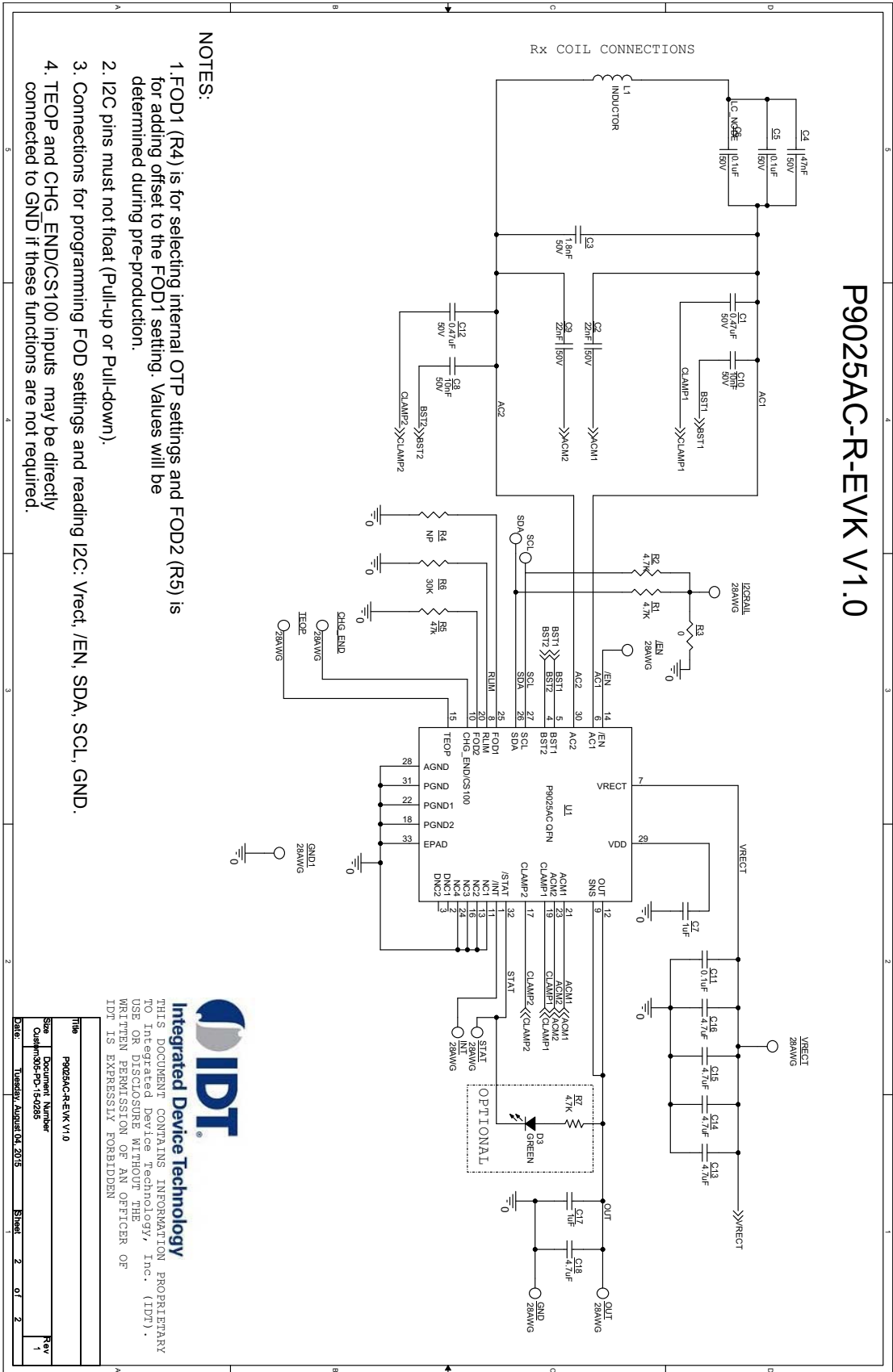

## Component Map

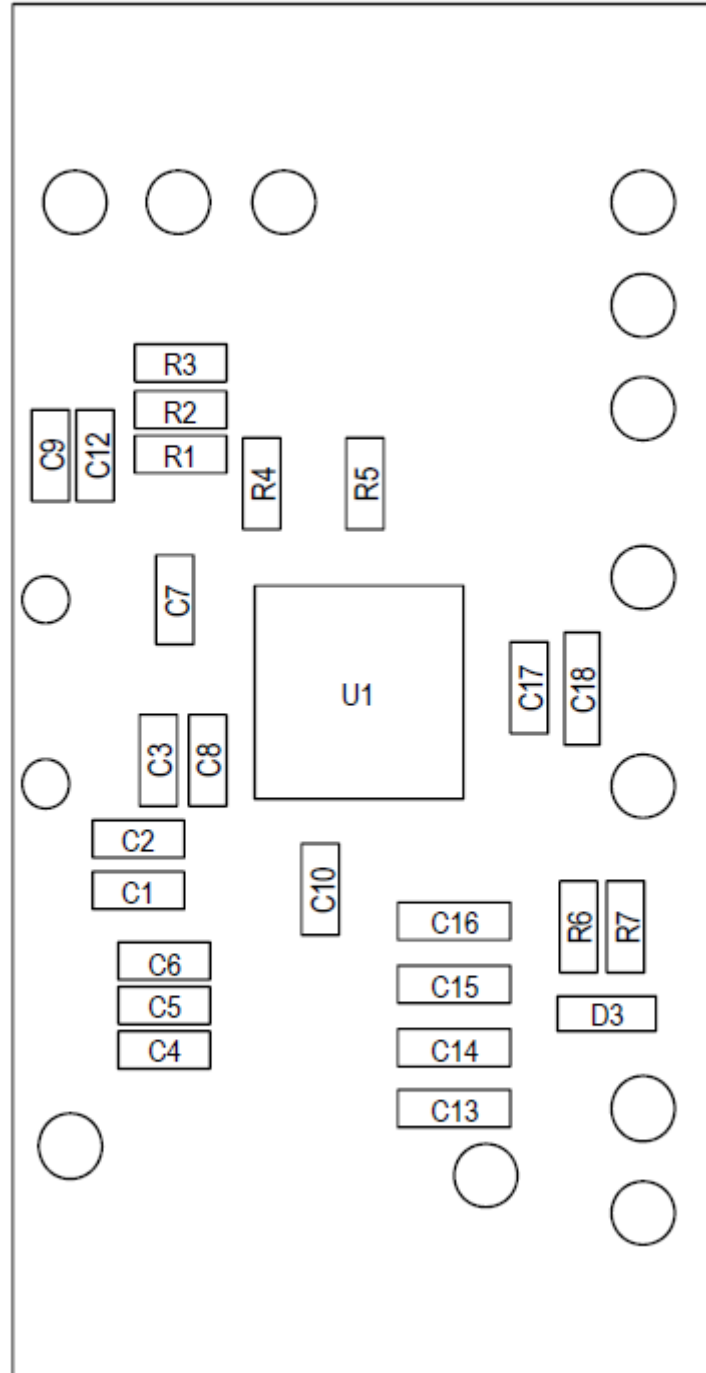

Symbol	Value	Purpose	Part Number
C1	0.47 $\mu$ F	Clamping capacitor for over-voltage limiting	UMK105ABJ474KV-F
C2	22 nF	Communication modulation capacitor	GRM155R71H223KA12J
C3	1.8 nF	Parallel resonant capacitor per WPC	GRM155R71H182KA01D
C4	47 nF	Series-resonant capacitor for LC tank circuit	GRM155C71H473KE19D
C5	0.1 $\mu$ F	Series-resonant capacitor for LC tank circuit	GRM155R61H104KE19D
C6	0.1 $\mu$ F	Series-resonant capacitor for LC tank circuit	GRM155R61H104KE19D
C7	1 $\mu$ F	Bulk capacitor for VDD internal regulator	C1005X5R1E105M050BC
C8	10 nF	Boost capacitor for BST2 pin	C1005X7R1H103K050BB
C9	22 nF	Communication modulation capacitor	GRM155R71H223KA12J
C10	10 nF	Boost capacitor for BST1 pin	C1005X7R1H103K050BB
C11	0.1 $\mu$ F	Bypass capacitor for VRECT output	C0603X5R1E104K030BB
C12	0.47 $\mu$ F	Clamping capacitor for over-voltage limiting	UMK105ABJ474KV-F
C13	4.7 $\mu$ F	Bulk capacitor for VRECT output	GRM188R61E475KE11D
C14	4.7 $\mu$ F	Bulk capacitor for VRECT output	GRM188R61E475KE11D
C15	4.7 $\mu$ F	Bulk capacitor for VRECT output	GRM188R61E475KE11D
C16	4.7 $\mu$ F	Bulk capacitor for VRECT output	GRM188R61E475KE11D
C17	1 $\mu$ F	LDO output capacitor.	C1005X5R1E105M050BC
C18	4.7 $\mu$ F	LDO output capacitor.	GRM188R61E475KE11D
CHG_END	28 AWG		–
D3	GREEN	Green LED for optional status indication	150060VS75000
/EN	28 AWG		–
GND	28 AWG		–
GND1	28 AWG		–
I2CRAIL	28 AWG		–
INT	28 AWG		–
L1	INDUCTOR	Primary coil for LC tank circuit	760308103202
OUT	28 AWG		–
R1	4.7 k $\Omega$	Pull-up for SDA pin	ERJ-2GEJ472X
R2	4.7 k $\Omega$	Pull-up for SCL pin	ERJ-2GEJ472X
R3	0 $\Omega$	Pull-down option to disable I <sup>2</sup> C function	RC0402JR-070RL
R4	NP	Resistor for adjusting FOD settings	–
R5	47 k $\Omega$	Resistor for adjusting FOD settings	ERJ-2GEJ473X
R6	30 k $\Omega$	Resistor for adjusting output current limit	ERJ-2RKF3002X
R7	4.7 k $\Omega$	Current limiting resistor for Green LED	ERJ-2GEJ472X
SCL	28 AWG		–
SDA	28 AWG		–
STAT	28 AWG		–
TEOP	28 AWG		–
U1	P9025AC QFN	Single-chip wireless receiver device	P9025AC-RNBGI
VRECT	28 AWG		–

A detailed bill-of-materials (BOM) spreadsheet can be found at [www.idt.com/P9025AC-R-EVK](http://www.idt.com/P9025AC-R-EVK)

## Top Layer

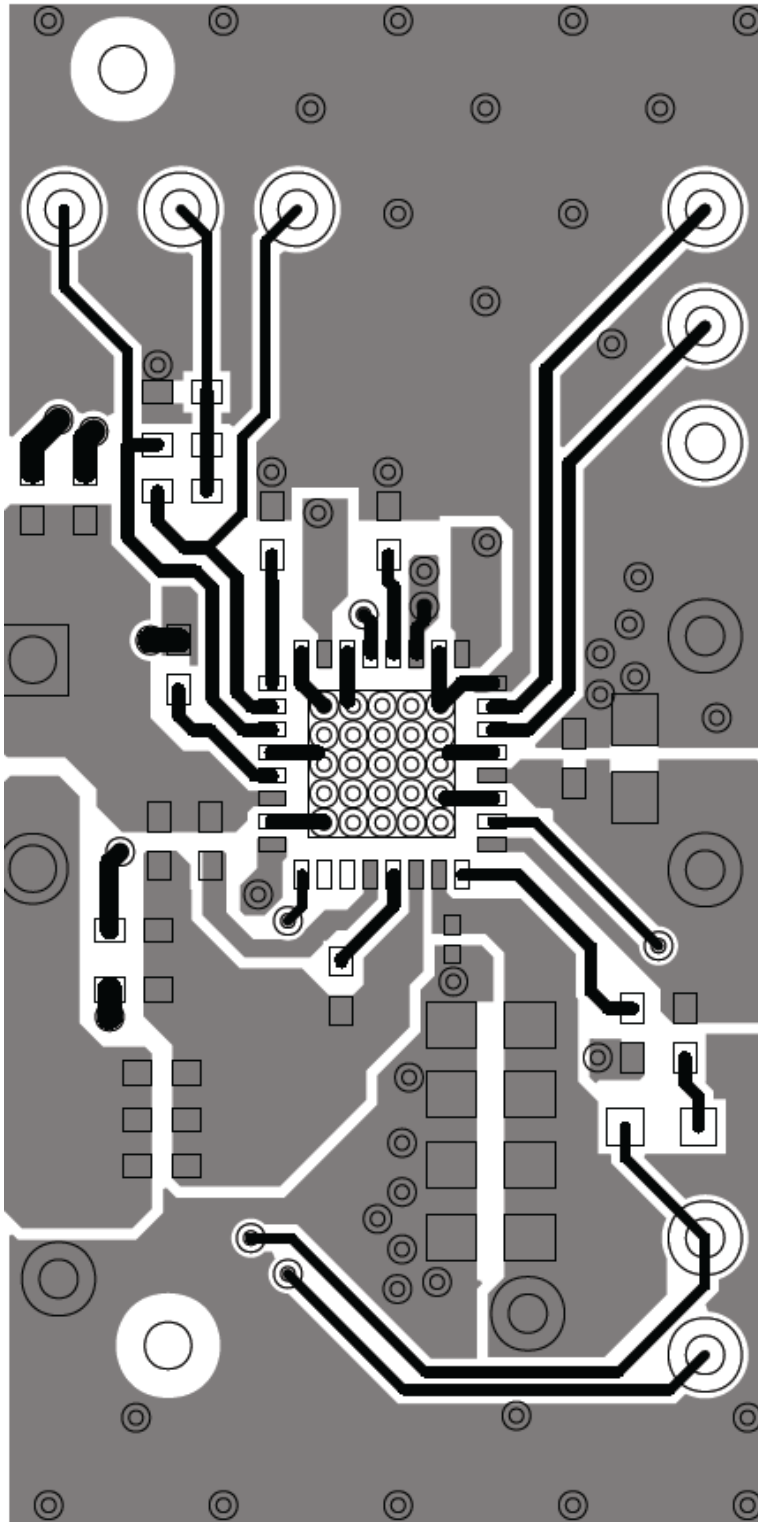

## Mid Layer 1

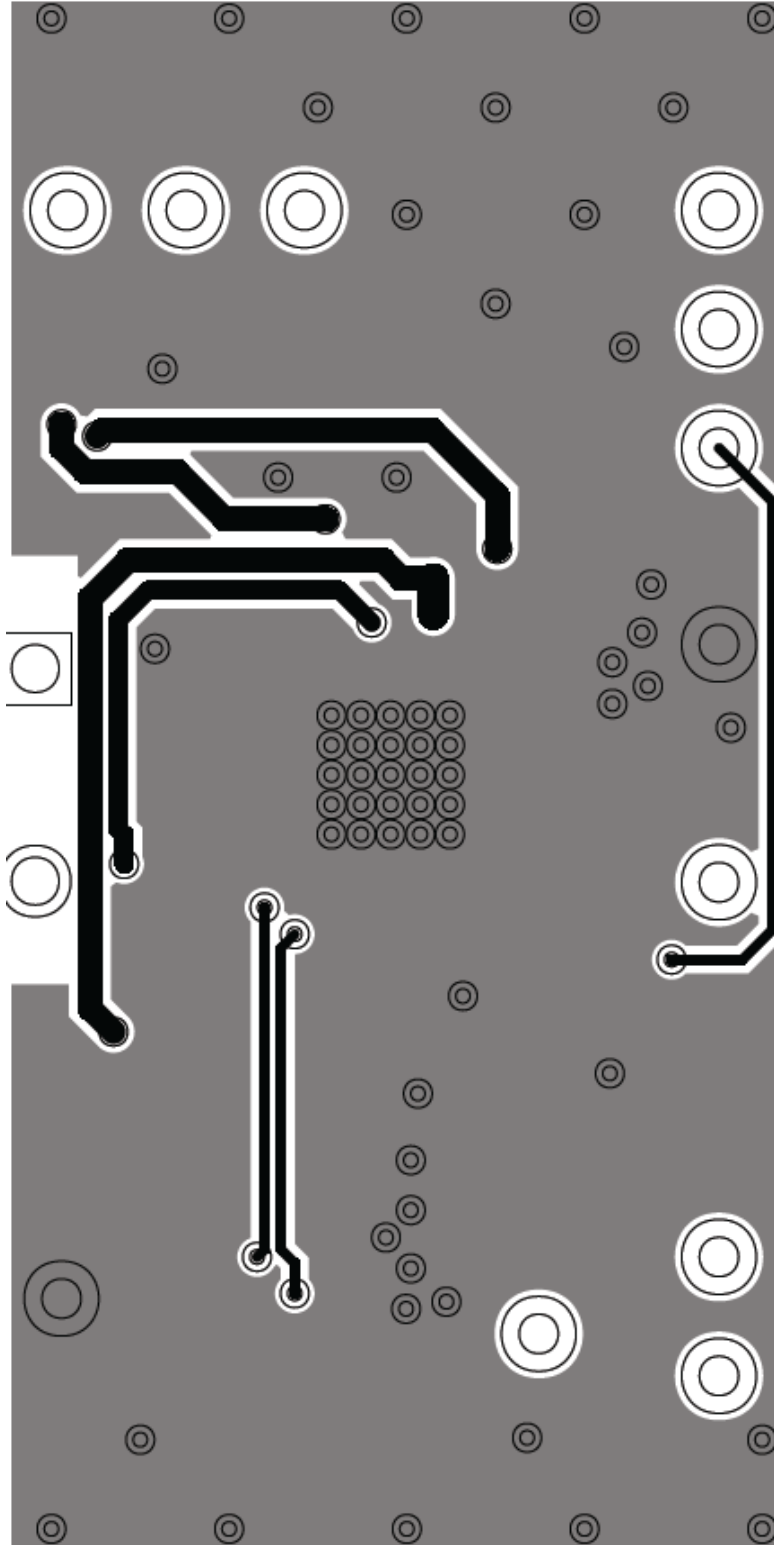



## Mid Layer 2

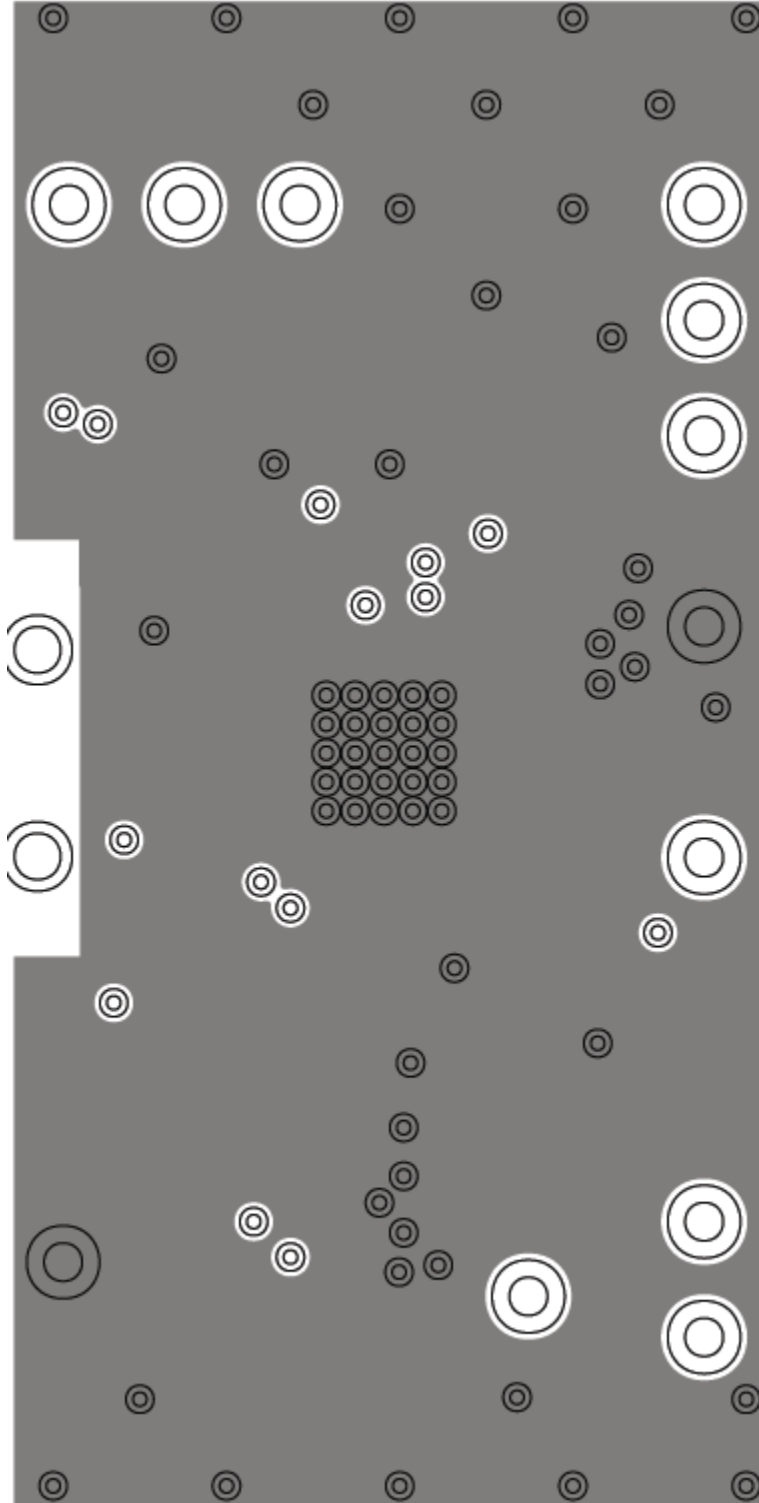

## Bottom Layer

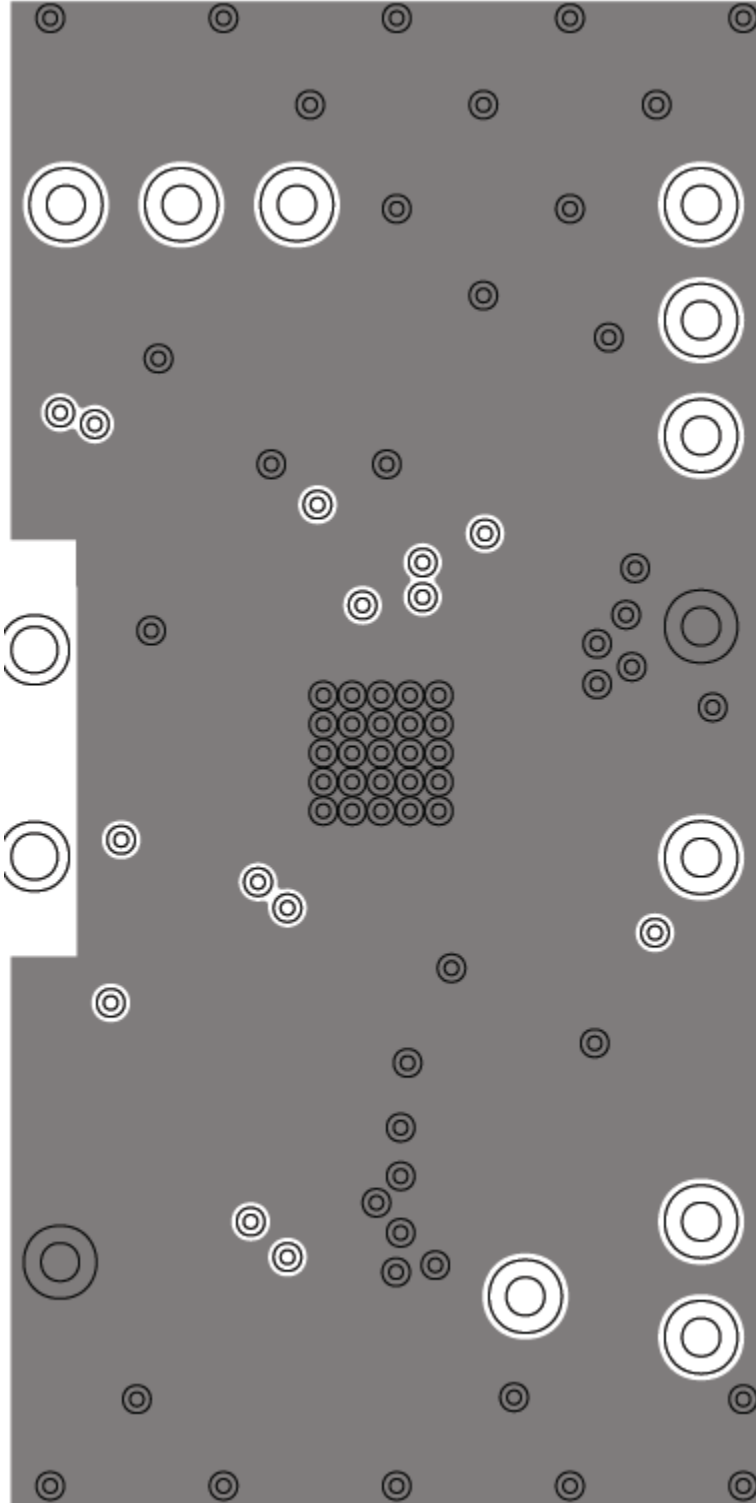



**Corporate Headquarters**  
6024 Silver Creek Valley Road  
San Jose, CA 95138 USA

**Sales**  
1-800-345-7015 or 408-284-8200  
Fax: 408-284-2775  
www.IDT.com

**Tech Support**  
[www.idt.com/go/support](http://www.idt.com/go/support)

DISCLAIMER Integrated Device Technology, Inc. (IDT) and its subsidiaries reserve the right to modify the products and/or specifications described herein at any time and at IDT's sole discretion. All information in this document, including descriptions of product features and performance, is subject to change without notice. Performance specifications and the operating parameters of the described products are determined in the independent state and are not guaranteed to perform the same way when installed in customer products. The information contained herein is provided without representation or warranty of any kind, whether express or implied, including, but not limited to, the suitability of IDT's products for any particular purpose, an implied warranty of merchantability, or non-infringement of the intellectual property rights of others. This document is presented only as a guide and does not convey any license under intellectual property rights of IDT or any third parties.

IDT's products are not intended for use in applications involving extreme environmental conditions or in life support systems or similar devices where the failure or malfunction of an IDT product can be reasonably expected to significantly affect the health or safety of users. Anyone using an IDT product in such a manner does so at their own risk, absent an express, written agreement by IDT.

Integrated Device Technology, IDT and the IDT logo are registered trademarks of IDT. Product specification subject to change without notice. Other trademarks and service marks used herein, including protected names, logos and designs, are the property of IDT or their respective third party owners.

Copyright ©2015 Integrated Device Technology, Inc.. All rights reserved.