

DATE CREATED		REVISIONS		
REV	DESCRIPTION	AUTHOR		
1/23/18	00	INITIAL RELEASE	Ruther	

NOTE: REFER TO DCP FOR OFFICIAL RELEASE DATE

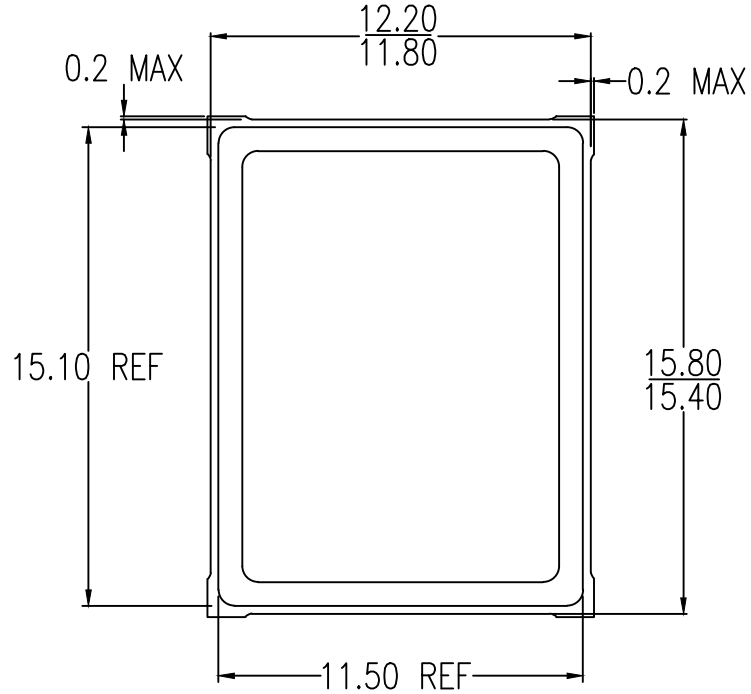

TOP VIEW

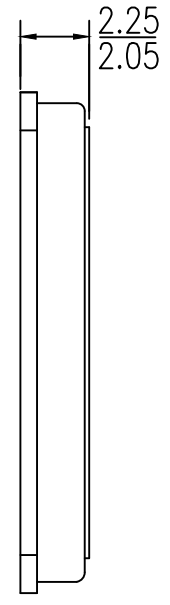

SIDE VIEW

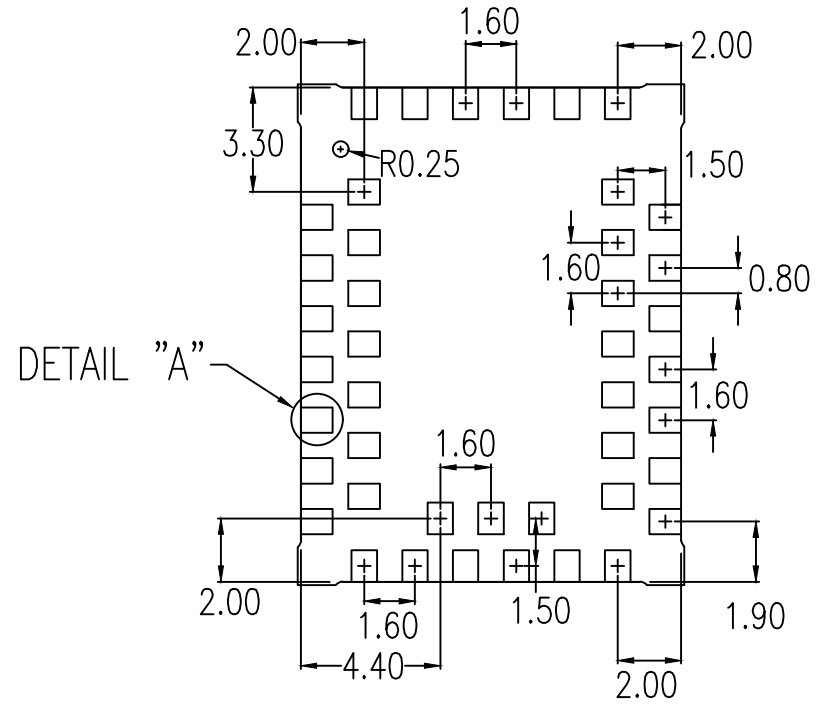

BOTTOM VIEW

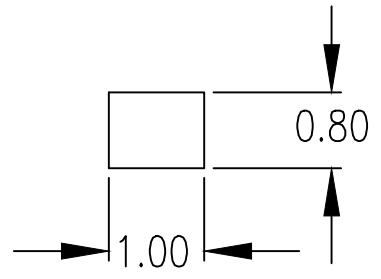

DETAIL "A"
(SAME DIMENSION FOR ALL PINS)

NOTE: ALL DIMENSIONS AND ANGLES IN MM.

TOLERANCES UNLESS SPECIFIED DECIMAL ANGULAR XX± ± XXX± XXXX±	 6024 Silver Creek Valley Road San Jose, CA 95138 PHONE: (408) 284-8200 www.IDT.com FAX: (408) 284-8591	
	TITLE ZWR4532 Package Outline Drawing 12.0 x15.6 x 2.15 mm Body 0.8mm Pitch MODO	
SIZE C	DRAWING No. PSC-4747	REV 00
DO NOT SCALE DRAWING		SHEET 1 OF 2

DATE CREATED	REVISIONS		
	REV	DESCRIPTION	AUTHOR
1/23/18	00	INITIAL RELEASE	Ruther
NOTE: REFER TO DCP FOR OFFICIAL RELEASE DATE			

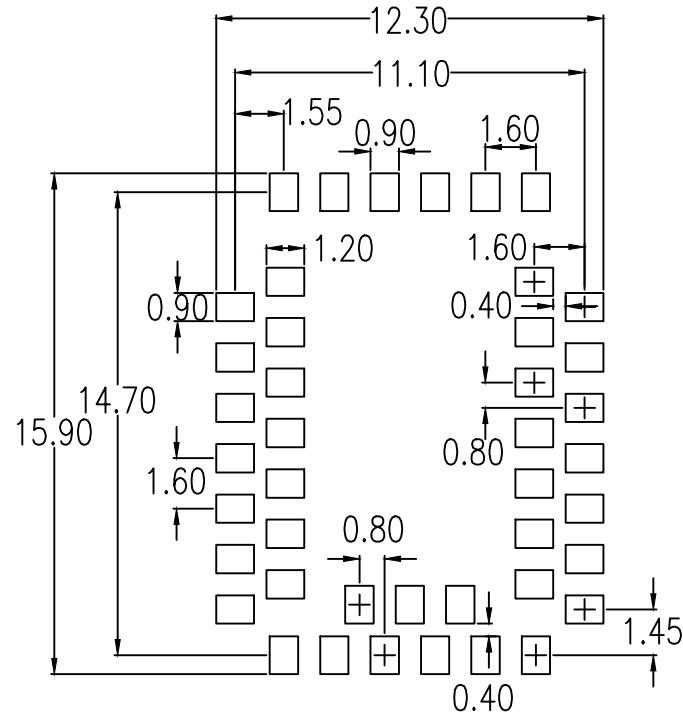

LAND PATTERN DIMENSION

NOTE:
1. ALL DIMENSIONS AND ANGLES IN MM.

TOLERANCES UNLESS SPECIFIED		 6024 Silver Creek Valley Road San Jose, CA 95138 PHONE: (408) 284-8200 www.IDT.com FAX: (408) 284-8591
DECIMAL	ANGULAR	
XXX±	±	
XXXX±		
TITLE ZWIR4532 Package Outline Drawing 12.0 x15.6 x 2.15 mm Body 0.8mm Pitch MOD0		
SIZE	DRAWING No.	REV
C	PSC-4747	00
DO NOT SCALE DRAWING		SHEET 2 OF 2